

JVC

SERVICE MANUAL

COLOUR TELEVISION

| |
|---------------|
| BASIC CHASSIS |
|---------------|

| |
|----|
| JK |
|----|

AV-29R8B_(PH)

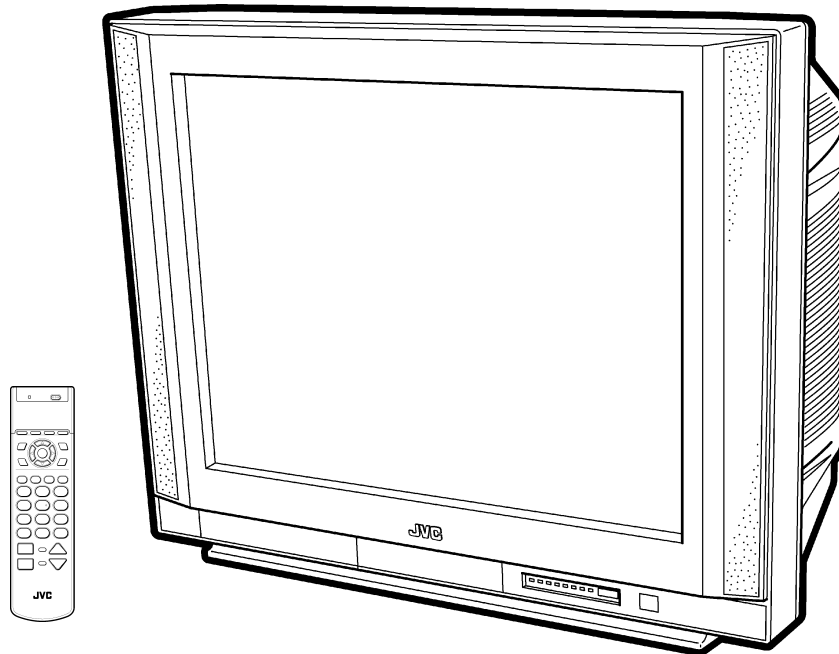

CONTENTS

| | |
|---|-----|
| ■ SPECIFICATIONS | 2 |
| ■ SAFETY PRECAUTIONS | 3 |
| ■ FEATURES | 4 |
| ■ FUNCTIONS | 5 |
| ■ SPECIFIC SERVICE INSTRUCTIONS | 6 |
| ■ SERVICE ADJUSTMENTS | 12 |
| ★ STANDARD CIRCUIT DIAGRAM (APPENDIX) | 2-1 |
| ■ PARTS LIST | 33 |

SPECIFICATIONS

| Item | CONTENTS | |
|-------------------------------------|---|---|
| Dimensions (W × H × D) | 732mm × 588mm × 508mm | |
| Mass | 52.0kg | |
| TV RF System | B / G, I, D / K, K1 & M | |
| Colour System | PAL, SECAM, NTSC3.58, NTSC4.43 | |
| Stereo System | Play back stereo only | |
| Receiving Frequency | VHF(L) 46.25MHz~168.25MHz VHF (H) 175.25MHz~463.25MHz UHF 471.25MHz ~ 863.25MHz CATV Mid(X-Z, S1-S10), Super(S11-S20), Hyper(S21-S41) bands receivable | |
| Intermediate Frequency | VIF Carrier 38.0MHz SIF Carrier 33.5MHz(4.5MHz), 32.5MHz(5.5MHz), 32.0MHz(6.0MHz), 31.5MHz(6.5MHz) | |
| Colour Sub Carrier Frequency | PAL 4.43MHz SECAM 4.40625MHz, 4.25MHz NTSC 3.58MHz / 4.43MHz | |
| Power Input | AC 110V~240V , 50/60Hz | |
| Power Consumption | 156W | |
| Picture Tube | Visible size : 68cm measured diagonally | |
| High Voltage | 32.0kV±1.5kV (at zero beam current) | |
| Speaker & Audio Output | Closed dome speaker 20W+20W (10cm round × 2 / 3.5cm round × 2) | |
| Video Audio Input terminals | | |
| Video1 | S-Video | Y : 1V _(p-p) positive (Negative sync provided, when terminated with 75 Ω) C : 0.286V _(p-p) (Burst signal, when terminated with 75 Ω) |
| | Video | 1V _(p-p) 75 Ω (RCA pin jack) |
| | Audio(L/R) | 500mV(rms) (-4dBs), High impedance (RCA pin jack) |
| Video2 | Video | 1V _(p-p) 75 Ω (RCA pin jack) |
| | Audio(L/R) | 500mV(rms) (-4dBs), High Impedance (RCA pin jack) |
| Video3 | Video/Y | V : Composite video 1V _(p-p) 75 Ω (RCA pin jack) Y : Component video 1V _(p-p) 75 Ω (RCA pin jack) |
| | Cb | Component video B-Y 0.7V _(p-p) 75 Ω (RCA pin jack) |
| | Cr | Component video R-Y 0.7V _(p-p) 75 Ω (RCA pin jack) |
| | Audio(L/R) | 500mV(rms) (-4dBs), High Impedance (RCA pin jack) |
| Video4 (Front terminal) | S-Video | Y : 1V _(p-p) positive (Negative sync provided, when terminated with 75 Ω) C : 0.286V _(p-p) (Burst signal, when terminated with 75 Ω) |
| | Video | 1V _(p-p) 75 Ω (RCA pin jack) |
| | Audio(L/R) | 500mV(rms) (-4dBs), High impedance (RCA pin jack) |
| Video Audio Output terminal | | |
| | Video | 1V _(p-p) 75 Ω (RCA pin jack) |
| | Audio(L/R) | 500mV(rms) (-4dBs), High Impedance (RCA pin jack) |
| Aerial Input Term | 75 Ω unbalanced, Coaxial | |
| Headphone jack | Stereo mini jack (φ 3.5mm) | |
| AV Compu Link terminal | AV Compu Link II , mini jack (φ 3.5mm) | |
| Remote Control Unit | RM-C111 (AA/R06 / UM-3 dry battery × 2) | |

Design & specifications are subject to change without notice.

SAFETY PRECAUTIONS

- The design of this product contains special hardware, many circuits and components specially for safety purposes. For continued protection, no changes should be made to the original design unless authorized in writing by the manufacturer. Replacement parts must be identical to those used in the original circuits. Service should be performed by qualified personnel only.
- Alterations of the design or circuitry of the products should not be made. Any design alterations or additions will void the manufacturer's warranty and will further relieve the manufacturer of responsibility for personal injury or property damage resulting therefrom.
- Many electrical and mechanical parts in the products have special safety-related characteristics. These characteristics are often not evident from visual inspection nor can the protection afforded by them necessarily be obtained by using replacement components rated for higher voltage, wattage, etc. Replacement parts which have these special safety characteristics are identified in the parts list of Service manual. **Electrical components having such features are identified by shading on the schematics and by (Δ) on the parts list in Service manual.** The use of a substitute replacement which does not have the same safety characteristics as the recommended replacement part shown in the parts list of Service manual may cause shock, fire, or other hazards.
- Don't short between the LIVE side ground and ISOLATED (NEUTRAL) side ground or EARTH side ground when repairing.**
Some model's power circuit is partly different in the GND. The difference of the GND is shown by the LIVE : (\perp) side GND, the ISOLATED(NEUTRAL) : (\downarrow) side GND and EARTH : (\oplus) side GND. Don't short between the LIVE side GND and ISOLATED(NEUTRAL) side GND or EARTH side GND and never measure with a measuring apparatus (oscilloscope etc.) the LIVE side GND and ISOLATED(NEUTRAL) side GND or EARTH side GND at the same time.
If above note will not be kept, a fuse or any parts will be broken.
- If any repair has been made to the chassis, it is recommended that the B1 setting should be checked or adjusted (See ADJUSTMENT OF B1 POWER SUPPLY).
- The high voltage applied to the picture tube must conform with that specified in Service manual. Excessive high voltage can cause an increase in X-Ray emission, arcing and possible component damage, therefore operation under excessive high voltage conditions should be kept to a minimum, or should be prevented. If severe arcing occurs, remove the AC power immediately and determine the cause by visual inspection (incorrect installation, cracked or melted high voltage harness, poor soldering, etc.). To maintain the proper minimum level of soft X-Ray emission, components in the high voltage circuitry including the picture tube must be the exact replacements or alternatives approved by the manufacturer of the complete product.
- Do not check high voltage by drawing an arc. Use a high voltage meter or a high voltage probe with a VTVM. Discharge the picture tube before attempting meter connection, by connecting a clip lead to the ground frame and connecting the other end of the lead through a 10k Ω 2W resistor to the anode button.
- When service is required, observe the original lead dress. Extra precaution should be given to assure correct lead dress in the high voltage circuit area. Where a short circuit has occurred, those components that indicate evidence of overheating should be replaced. Always use the manufacturer's replacement components.

9. Isolation Check

(Safety for Electrical Shock Hazard)

After re-assembling the product, always perform an isolation check on the exposed metal parts of the cabinet (antenna terminals, video/audio input and output terminals, Control knobs, metal cabinet, screw heads, earphone jack, control shafts, etc.) to be sure the product is safe to operate without danger of electrical shock.

(1) Dielectric Strength Test

The isolation between the AC primary circuit and all metal parts exposed to the user, particularly any exposed metal part having a return path to the chassis should withstand a voltage of 3000V AC (r.m.s.) for a period of one second.

(. . . . Withstand a voltage of 1100V AC (r.m.s.) to an appliance rated up to 120V, and 3000V AC (r.m.s.) to an appliance rated 200V or more, for a period of one second.)

This method of test requires a test equipment not generally found in the service trade.

(2) Leakage Current Check

Plug the AC line cord directly into the AC outlet (do not use a line isolation transformer during this check.). Using a "Leakage Current Tester", measure the leakage current from each exposed metal part of the cabinet, particularly any exposed metal part having a return path to the chassis, to a known good earth ground (water pipe, etc.). Any leakage current must not exceed 0.5mA AC (r.m.s.).

However, in tropical area, this must not exceed 0.2mA AC (r.m.s.).

● Alternate Check Method

Plug the AC line cord directly into the AC outlet (do not use a line isolation transformer during this check.). Use an AC voltmeter having 1000 ohms per volt or more sensitivity in the following manner. Connect a 1500 Ω 10W resistor paralleled by a 0.15 μ F AC-type capacitor between an exposed metal part and a known good earth ground (water pipe, etc.). Measure the AC voltage across the resistor with the AC voltmeter. Move the resistor connection to each exposed metal part, particularly any exposed metal part having a return path to the chassis, and measure the AC voltage across the resistor. Now, reverse the plug in the AC outlet and repeat each measurement. Any voltage measured must not exceed 0.75V AC (r.m.s.). This corresponds to 0.5mA AC (r.m.s.).

However, in tropical area, this must not exceed 0.3V AC (r.m.s.). This corresponds to 0.2mA AC (r.m.s.).

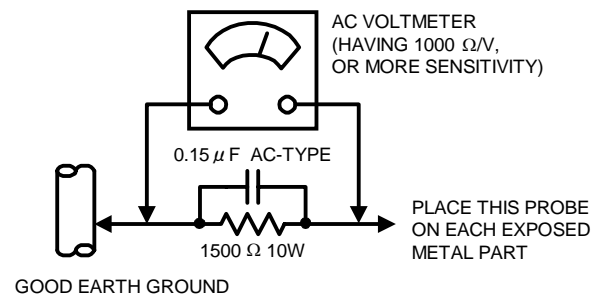

FEATURES

- By preference, users can select the picture size from REGULAR, ZOOM, 16:9 modes.
- Because this TV unit corresponds to multiplex broadcast, users can enjoy music programs and sporting events with live realism. In addition, BILINGUAL programs can be heard in their original language.
- Users can make fun to connect the Digital Video Disk player by using the component video signal input terminal.
- Built-in ECO (ECONOMY, ECOLOGY) MODE.
In accordance with the brightness in a room, the brightness and/or contrast of the picture can be adjusted automatically to make the optimum picture which is easy on the eye.
- I²C Bus controls the many ICs which have various functions each other.

I²C BUS CONTROL SYSTEM CHART

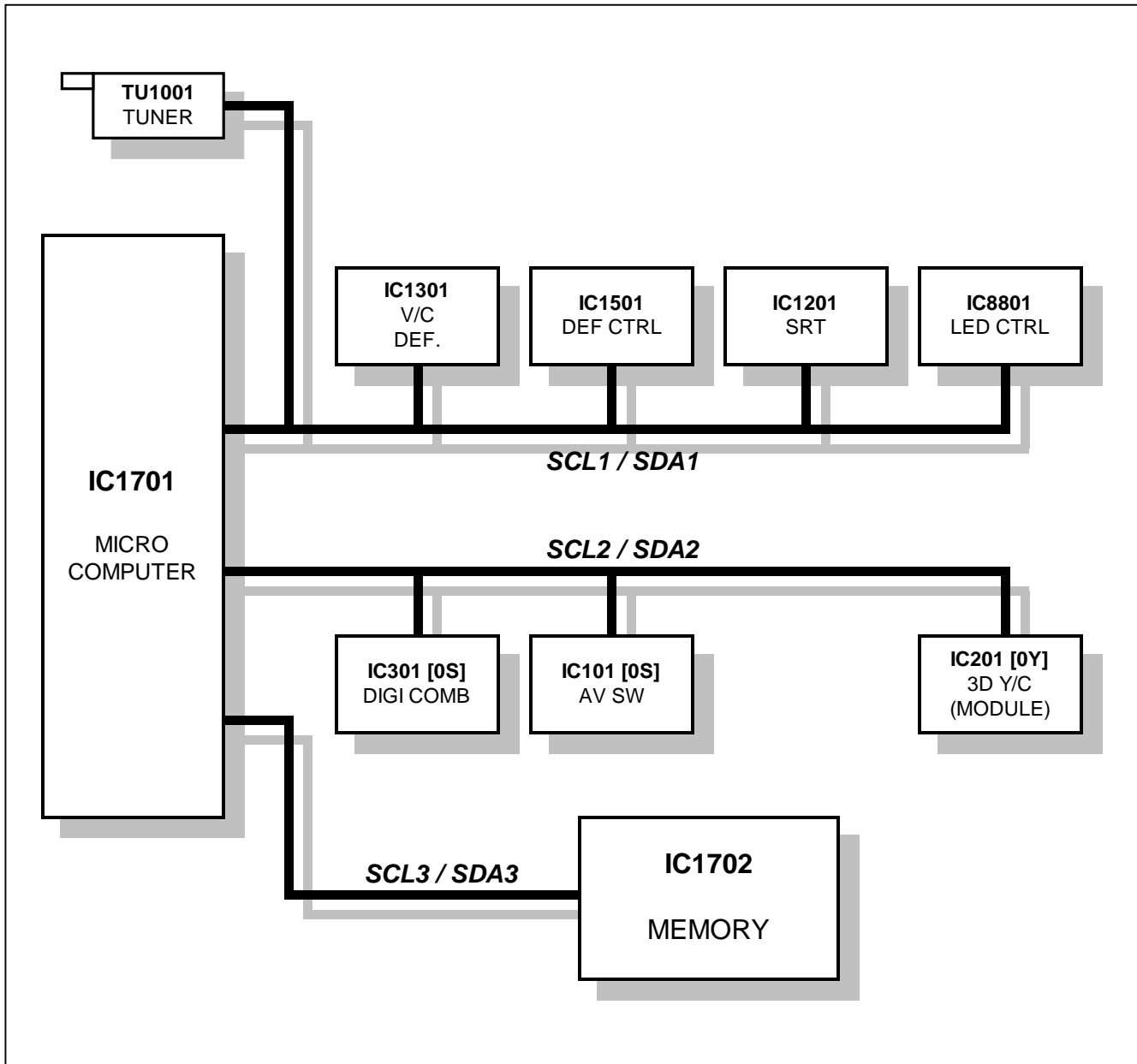

FUNCTIONS

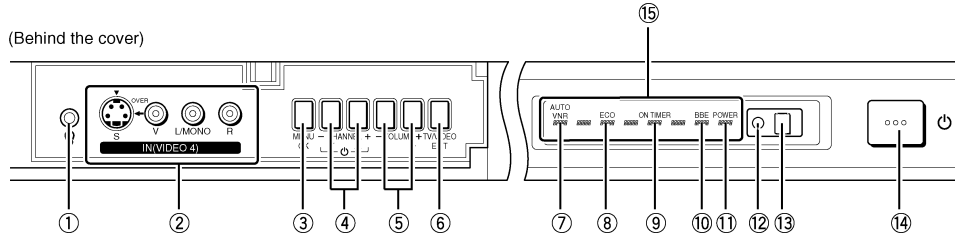

- ① Headphone jack
- ② Video-4 terminal
- ③ MENU OK
- ④ Channel +/- (MENU UP/DOWN)
- ⑤ Volume +/- (MENU LEFT/RIGHT)
- ⑥ TV/VIDEO
- ⑦ AUTO VNR
- ⑧ ECO
- ⑨ ON TIMER
- ⑩ BBE
- ⑪ POWER
- ⑫ ECO sensor
- ⑬ Remote control sensor
- ⑭ Main POWER SW
- ⑮ Dancing LED

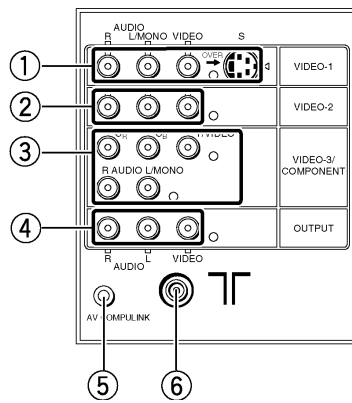

- ① Video-1 terminal (S, V, L, R)
- ② Video-2 terminal (V, L, R)
- ③ Video-3 terminal / Component (V/Y, Cb, Cr, L, R)
- ④ Output terminal (V, L, R)
- ⑤ AV COMPULINK terminal
- ⑥ Aerial socket (ANT Terminal)

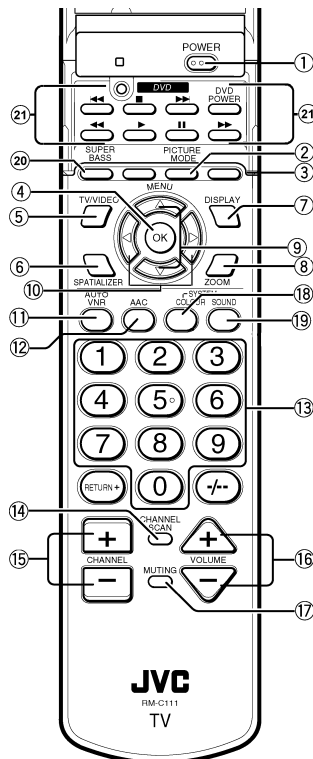

- ① POWER Key
- ② PICTURE MODE Key
- ③ COLOUR Key
- ④ MENU OK Key
- ⑤ TV/VIDEO Key
- ⑥ SPATIALIZER Key
- ⑦ DISPLAY Key
- ⑧ ZOOM Key
- ⑨ MENU UP/DOWN (▲ / ▼) Key
- ⑩ MENU LEFT/RIGHT (◀ / ▶) Key
- ⑪ AUTO VNR Key
- ⑫ AAC Key
- ⑬ CHANNEL Key
- ⑭ CHANNEL SCAN Key
- ⑮ CHANNEL +/- Key
- ⑯ VOLUME +/- Key
- ⑰ MUTING Key
- ⑱ COLOUR SYSTEM Key
- ⑲ SOUND SYSTEM Key
- ⑳ SUPER BASS Key
- ㉑ DVD CONTROL Key

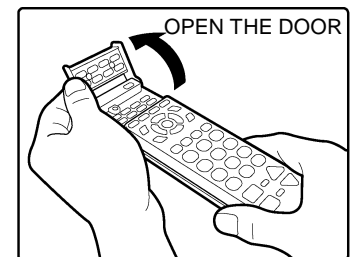

SPECIFIC SERVICE INSTRUCTIONS

DISASSEMBLY PROCEDURE

REMOVING THE REAR COVER

1. Disconnect the power plug from wall outlet.
2. As shown in the Fig.2, remove the **16** screws marked **(A)** .
3. Withdraw the rear cover toward you.

REMOVING THE AV TERMINAL BOARD

- After removing the REAR COVER.
1. As shown in Fig.2, remove the **5** screws marked **(B)** .
 2. Then remove the AV TERMINAL BOARD.

REMOVING THE CHASSIS

- After removing the REAR COVER and AV TERMINAL BOARD.
1. Slightly raise the both sides of the chassis by hand and remove the two claws under the both sides of the chassis from the front cabinet.
 2. Withdraw the chassis backward.
(If necessary, take off the wire clamp, connectors etc.)

REMOVING THE DOME SPEAKER BOX

- After removing the REAR COVER.
1. As shown in Fig. 2, removing the **2** screws marked **(C)** , then remove the dome speaker box backward.
 2. Follow the same steps when removing the other hand dome speaker box.

NOTE : When removing the screws marked **(C)** of the dome speaker box, remove the lower side screw first, and then remove the upper one.

REMOVING THE TOP GRILLE

- After removing the REAR COVER.
1. As shown in Fig.2, removing the **4** screws marked **(D)** .
 2. Pull up the TOP GRILLE to remove it.

REMOVING THE CONTROL BASE

- After removing the CHASSIS.
1. As shown in Fig.1, while pushing down the claws marked **(E)**, remove the CONTROL BASE in the arrow direction **(F)** .

CHECKING THE PW BOARD

To check the PW Board from bottom side.

1. Pull out the CHASSIS (refer to REMOVING THE CHASSIS).
2. Erect the chassis vertically so that you can easily check the bottom side of the PW Board.

CAUTION

- When erecting the CHASSIS, be careful so that there will be no contacting with other PW Board.
- Before turning ON power, make sure that the wire connector is properly connected.
- **When conducting a check with power supplied, be sure to confirm that the CRT EARTH WIRE (BRAIDED ASS' Y) is connected to the CRT SOCKET PW board.**

WIRE CLAMPING AND CABLE TYING

1. Be sure to clamp the wire.
2. Never remove the cable tie used for tying the wires together.
Should it be inadvertently removed, be sure to tie the wires with a new cable tie.

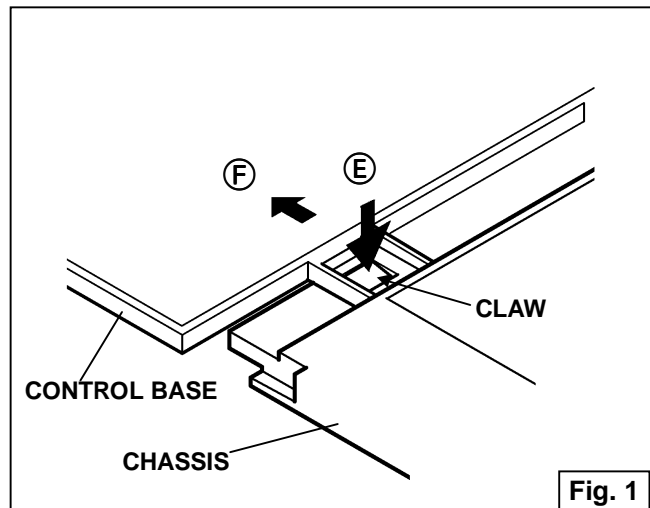

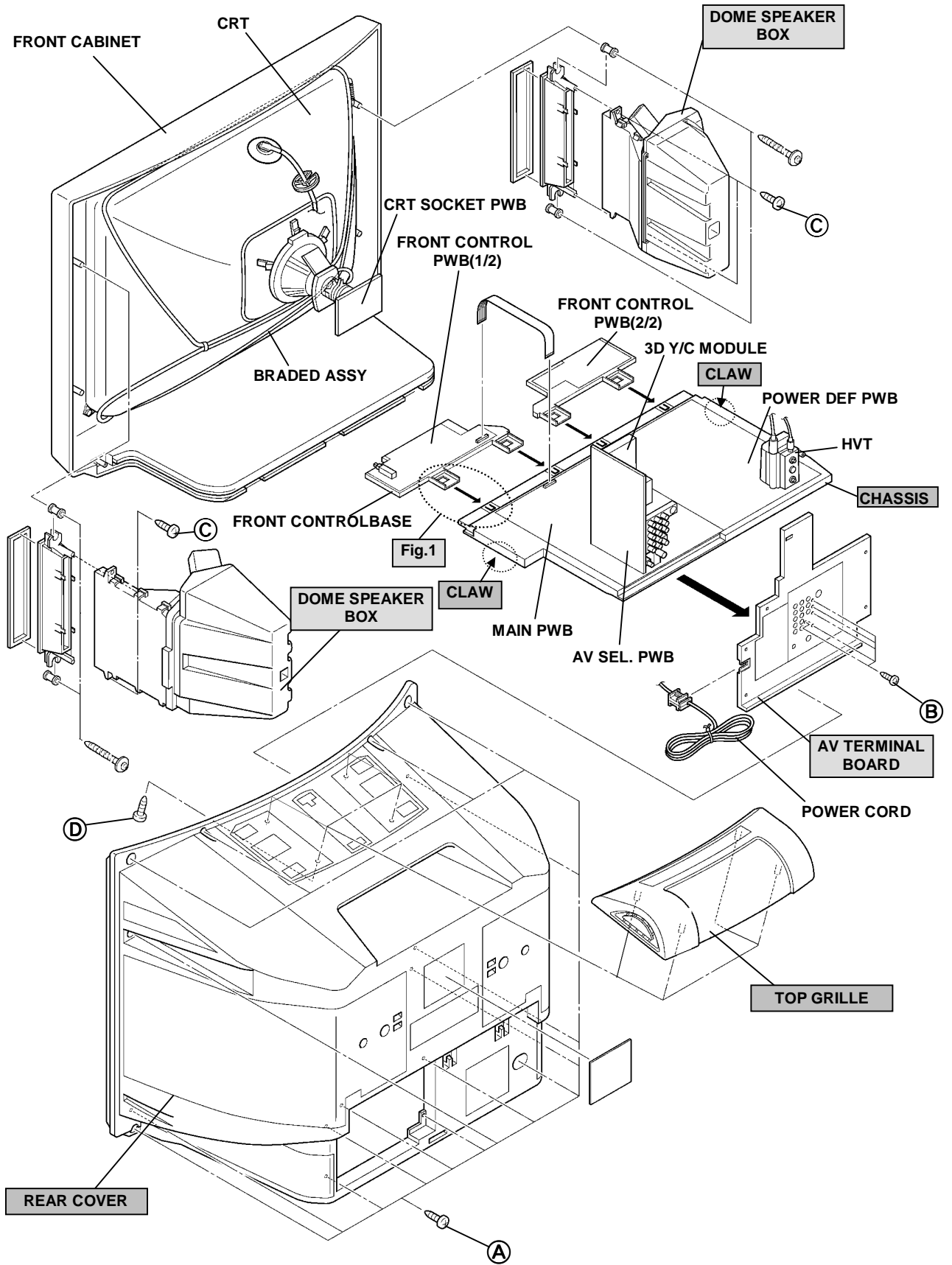

Fig.2

REMOVING THE CRT

- Replacement of the CRT should be performed by 2 or more persons.
- After removing the cover, chassis etc.

1. Putting the CRT change table on soft cloth, the CRT change table should also be covered with such soft cloth (shown in Fig.3).
2. While keeping the surface of CRT down, mount the TV set on the CRT change table balanced will as shown in Fig.3.
3. Remove 4 screws marked by arrows with a box type screw driver as shown in Fig.4.

Since the cabinet will drop when screws have been removed, be sure to support the cabinet with hands.

4. After 4 screws have been removed, put the cabinet slowly on cloth (At this time, be carefully so as not to damage the front surface of the cabinet) shown in Fig.5.

The CRT should be assembled according to the opposite sequence of its dismantling steps.

The CRT change table should preferably be smaller than the CRT surface, and its height be about 35cm.

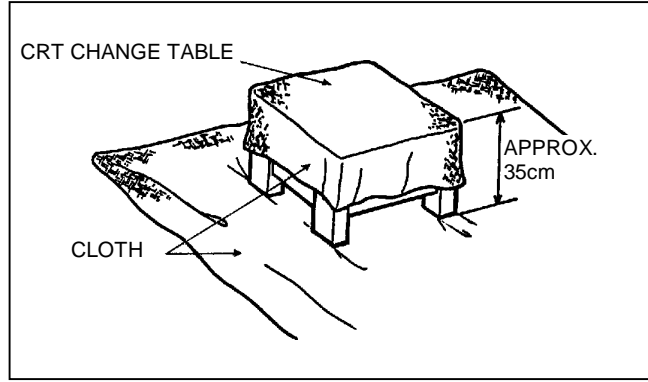

Fig. 3

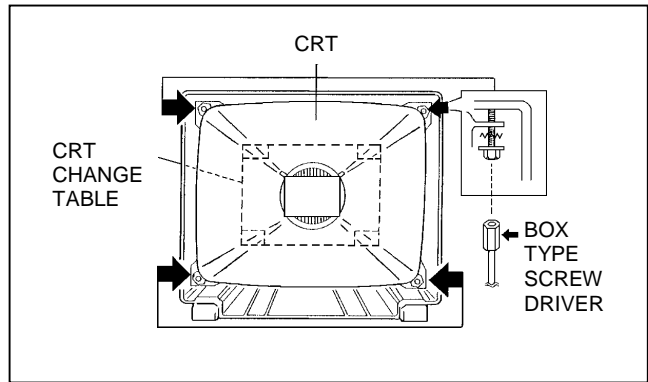

Fig. 4

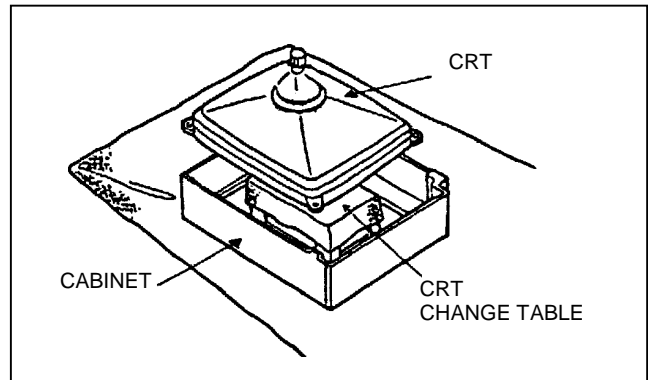

Fig. 5

COATING OF SILICON GREASE FOR ELECTRICAL INSULATION ON THE CRT ANODE CAP SECTION.

Subsequent to replacement of the CRT and HV transformer or repair of the anode cap, etc. by dismantling them, be sure to coat silicon grease for electrical insulation as shown in Fig.6.

Wipe around the anode button with clean and dry cloth. (Fig.6) Coat silicon grease on the section around the anode button. At this time, take care so that any silicon greases dose not stick to the anode button. (Fig.7)

Silicon grease product No. KS - 650N

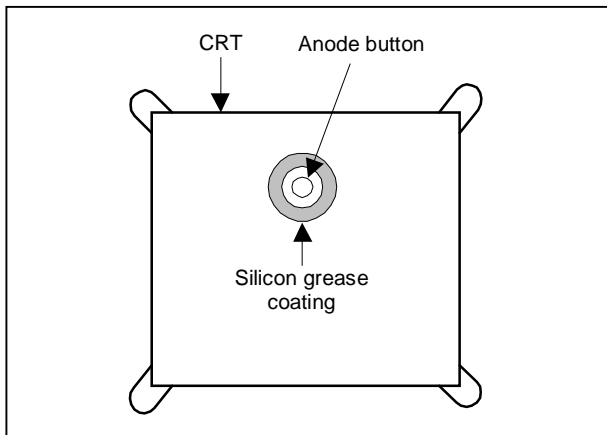

Fig. 6

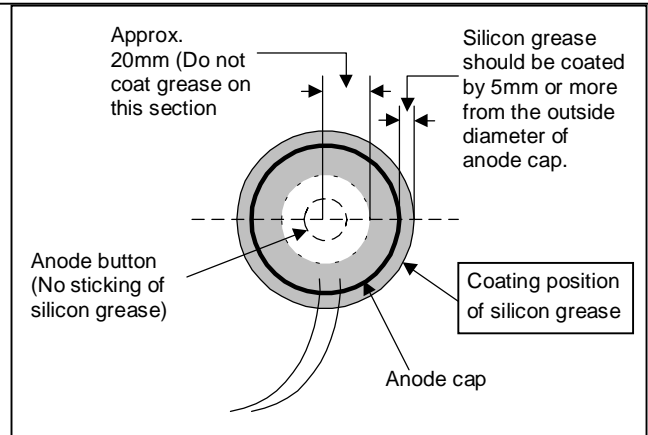

Fig. 7

REPLACEMENT OF MEMORY ICs

1. Memory ICs

This model uses memory ICs. This memory IC data are for proper operation of the video and deflection circuits. When replacing, be sure to use ICs written with the initial values of data.

2. Procedure for replacing memory ICs

(1) Power off

Switch off the power and disconnect the power plug from the wall outlet.

(2) Replace the memory IC

Be sure to use memory ICs written with the initial data values.

(3) Power on

Connect the power plug into the wall outlet and switch power on.

(4) Check and set SYSTEM CONSTANT SET

★ It must not adjust without signal / should be OPEN the remote control unit door

- 1) Press the **DISPLAY** key and the **PICTURE MODE** key of the REMOTE CONTROL UNIT simultaneously.
- 2) The SERVICE MENU screen of Fig. 1 will be displayed.
- 3) While the SERVICE MENU is displayed, again press the **DISPLAY** key and **PICTURE MODE** key simultaneously, and the SYSTEM CONSTANT SET screen of Fig. 2 will be displayed.
- 4) Check the setting values of the SYSTEM CONSTANT SET of Table 1 in page later. If the value is different, select the setting item with the **MENU UP/DOWN** key, and set the correct value with the **MENU LEFT/RIGHT** key.
- 5) Press the **OK** key to memorize the setting value.
- 6) Press the **DISPLAY** key twice, and return to the normal screen.

(5) Receive channel setting

Refer to the OPERATING INSTRUCTIONS, and set the receive channels as described.

(6) User settings

Check the user setting items according to Table 2. Where these do not agree, refer to the OPERATING INSTRUCTIONS.

(7) SERVICE MENU setting

Verify what to see in the SERVICE MENU, and set what ever in necessary.

KEY ASSIGNMENT OF REMOTE CONTROL UNIT

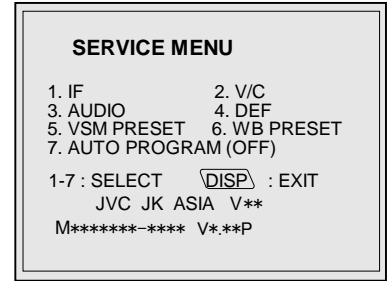
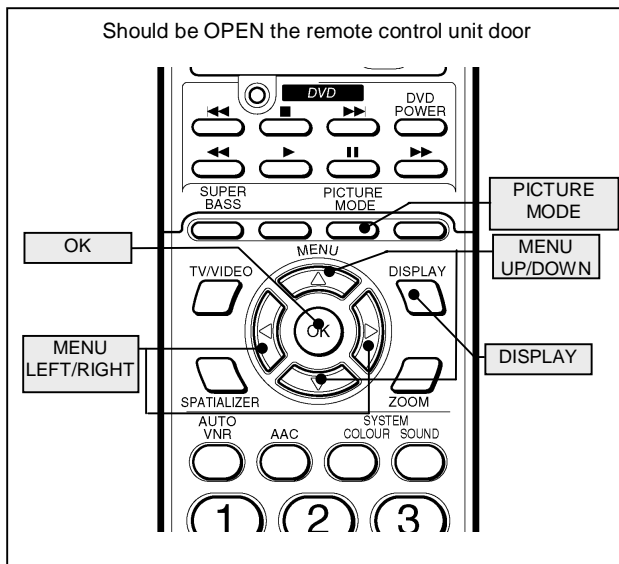

Fig.1

SYSTEM CONSTANT SET
 MODEL = JK - ASIA (V*, ***)
 COLOUR : MULTI
 MSP : NO
 SUPER BASS : YES
 CENTER SPEAKER : NO
 TEXT : NO
 ◀▶ [OK]: STORE [DISP]: EXIT

SYSTEM CONSTANT(1/3)

SYSTEM CONSTANT SET
 MODEL = JK : ASIA (V*, ***)
 BLUE BACK MUTE : NO
 VOLUME LIMIT : YES
 COLOUR AUTO : NO
 TILT : YES
 C-TRAP : 1
 ◀▶ [OK]: STORE [DISP]: EXIT

SYSTEM CONSTANT(2/3)

SYSTEM CONSTANT SET
 MODEL = JK : ASIA (V*, ***)
 E.M.C : NO
 N/S WHITE BACK : NO
 7 LED SPEED : 100
 ◀▶ [OK]: STORE [DISP]: EXIT

SYSTEM CONSTANT(3/3)

Fig.2

INITIAL SETTING VALUES OF SYSTEM CONSTANT SET (TABLE 1)

| CONTENTS | VARIABLE RANGE | INITIAL SETTING VALUE |
|----------------|--|-----------------------|
| COLOUR | ▶ MULTI → TRIPLE → PAL | MULTI |
| MSP | ▶ YES → NO | NO |
| SUPER BASS | ▶ YES → NO | YES |
| CENTER SPEAKER | ▶ YES → NO | NO |
| TEXT | ▶ YES → NO | NO |
| BLUE BACK MUTE | ▶ YES → NO | NO |
| VOLUME LIMIT | ▶ YES → NO | YES |
| COLOUR AUTO | ▶ YES → NO | NO |
| TILT | ▶ YES → NO | YES |
| C-TRAP | ▶ 1 → 0 | 1 |
| E.M.C | ▶ YES → NO | NO |
| N/S WHITE BACK | ▶ YES → NO | NO |
| 7 LED SPEED | ▶ 00 → 10 → 20 → 30 → → 1250 → 1260 → 1270 | 100 |

USER SETTING CONDITIONS (TABLE2)

| PICTURE SETTING | | FEATURES | |
|------------------|----------------------|-------------------|---------------------|
| CONTRAST |] CENTER | SLEEP TIMER | OFF |
| BRIGHT | | ON TIMER | — |
| SHARP | | BLUE BACK | ON |
| COLOUR | | CHILD LOCK | OFF |
| PICTURE | | CHANNEL GUARD | — |
| WHITE BALANCE | | AUTO SHUT OFF | OFF |
| PICTURE FEATURES | | VIDEO-3 SETTING | VIDEO |
| A.A.C | ON (VIDEO / OFF(TV)) | INSTALL | |
| AUTO VNR | AUTO | LANGUAGE | ENGLISH |
| COLOUR SYSTEM | AUTO | DEMO | |
| ZOOM | REGULAR | DEMO | OFF |
| ECO SENSER | OFF | OTHERS | |
| PICTURE TILT | CENTER | MAIN POWER | OFF |
| SOUND SETTING | | VOLUME | PROPER SOUND VOLUME |
| BILINGUAL MODE | STEREO | CHANNEL PRESET | REFER TO INST BOOK |
| BASS |] CENTER | CHANNEL POSITION | 1 POSITION |
| TREBLE | | SUB POWER | ON |
| BALANCE | ON | ON SCREEN DISPLAY | INDICATION |
| AI VOLUME | OFF | ZOOM MODE | REGULAR |
| BBE | OFF | TV/VIDEO | TV |
| SPATIALIZER | OFF | SOUND SYSTEM | B/G |
| SUPER BASS | ON | | |

SERVICE MENU SETING ITEMS (TABLE 3)

| Setting item | Setting value | Setting item | Setting value |
|-----------------------------|---|---|--|
| 1. IF | VCO (CW)) | 4. DEF | 1. V-SHIFT 2. V-SIZE 3. SUB TITLE 4. H-CENT 5. H-SIZE 6. EW-PIN 7. TRAPEZ 8. EW. COR. L 9. EW. COR. H 10. V. S-COR 11. V-LIN 12. H-BLK-R 13. H-BLK-L 14. V-EHT 15. H-EHT 16. EHT-GAIN |
| 2. V / C | 1. CUT OFF (R, G, B) 2. DRIVE (R, B) 3. BRIGHT 4. CONT. 5. COLOUR 6. TINT 7. BLACK OFFSET (R-Y, B-Y) 8. SHARP | 5. VSM PRESET BRIGHT STANDARD SOFT | 1. BRIGHT 2. CONT 3. COLOUR 4. SHARP 5. TINT |
| 3. AUDIO (Do not adjust) | 1. ERROR LIMIT 2. A2 ID THR 3. BASS 4. TREBLE | 6. WB PRESET COOL MID WARM | 1. R DRIVE 2. B DRIVE |
| | | 7. AUTO PROGRAM (Do not adjust) | ON / OFF * After finish to adjust, press the 7-key to preset "7.AUTO PROGRAM(ON)" in the Service mode. |

SERVICE ADJUSTMENTS

BEFORE STARTING SERVICE ADJUSTMENT

1. There are 2 ways of adjusting this TV: One is with the REMOTE CONTROL UNIT and the other is the conventional method using adjustment parts and components.
2. The adjustment with the REMOTE CONTROL UNIT is made on the basis of the initial setting values. The setting values which adjust the screen to its optimum condition may differ from the initial setting values.
3. Make sure that connection is correctly made to AC power source.
4. Turn on the power of the set and equipment before use, and start the adjustment procedures after waiting at least 30 minutes.
5. Unless otherwise specified, prepare the most suitable reception or input signal for adjustment.
6. Never touch any adjustment parts, which are not specified in the list for this adjustment variable resistors, transforms, condensers, etc.
7. Preparation for adjustment (presetting)
Unless otherwise specified in the adjustment items, preset the following functions with the REMOTE CONTROL UNIT.

User mode setting condition

| | |
|--------------------|----------|
| PICTURE MODE (VSM) | STANDARD |
| WHITE BALANCE | COOL |
| ZOOM | REGULAR |
| CONTRAST | CENTER |
| BRIGHT | CENTER |
| SHARP | CENTER |
| COLOUR | CENTER |
| A.A.C | OFF |
| AUTO VNR | OFF |
| PICTURE TILT | CENTER |
| BLUE BACK | OFF |
| AUTO SHUTOFF | OFF |
| ECO SENSOR | OFF |
| AI VOLUME | OFF |
| BBE | OFF |
| SUPER BASS | OFF |
| SLEEP TIMER | OFF |
| BALANCE | CENTER |
| SPATIALIZER | OFF |

MEASURING INSTRUMENT AND FIXTURES

1. DC voltmeter (or digital voltmeter)
2. Oscilloscope
3. Signal generator (Pattern generator) [PAL / SECAM / NTSC]
4. Remote control unit

ADJUSTMENT CONTENTS

- CHECK ITEMS BEFFOR ADJUSTMENT
- FOCUS ADJUSTMENT
- CHECK OF IF CIRCUIT
- SETTING OF VSM PRESET
- SETTING OF WHITE BALANCE PRESET
- VIDEO / CHROMA CIRCUIT ADJUSTMENT
- DEFLECTION CIRCUIT ADJUSTMENT
- AUDIO CIRCUIT ADJUSTMENT [**Do not adjust**]
- PURITY, CONVERGENCE ADJUSTMENT

BASIC OPERATION OF SERVICE MENU

1. The adjustment using SERVICE MENU

The following adjustment items use the SERVICE MENU in the series of the adjustment. The adjustments are made on the basis of the initial setting values. The adjustment values which adjust the screen to the optimum condition can be different from the initial setting values. With the SERVICE MENU, various settings can be made, and they are broadly classified in the following items of settings.

- IF Adjustment of the IF circuits.
- V/C Adjustment of the VIDEO/CHROMA circuit.
- AUDIO Adjustment of the sound circuit **[Do not adjust]**.
- DEF Adjustment of the DEFLECTION circuit for each aspect mode given below
REGULAR (50/60Hz) / ZOOM (50/60Hz) / 16:9 (50/60Hz)
- VSM PRESET Adjustment of the initial setting values of VSM condition as BRIGHT, STANDARD and SOFT.
(VSM : Video Status Memory)
- WB PRESET Adjustment of the initial setting value of WHITE BALANCE PRESET (W B) values as COOL, MID and WARM.
- AUTO PROGRAM By turning the power switch ON, you can get the state of AUTO PROGRAM **[Do not adjust]**.

2. Key operation of the SERVICE MENU

[Enter to SERVICE MENU]

Press the **DISPLAY** key and the **PICTURE MODE** key of the REMOTE CONTROL UNIT simultaneously. Then enter the SERVICE MENU mode as shown in Fig.1.

[Select the SUB MENU from SERVICE MENU]

In SERVICE MENU, press the 1~7 key of the remote control unit, to select any of the adjustment items.

The colours which selected item characters are changed.

[Method of setting]

1. IF

[VCO (CW)]

- ① 1 Key Select **1.IF**.
- ② The VCO (CW) screen will be displayed.
- ③ DISPLAY Key ... As you press this key, you will return to the **SERVICE MENU**.

SERVICE MENU

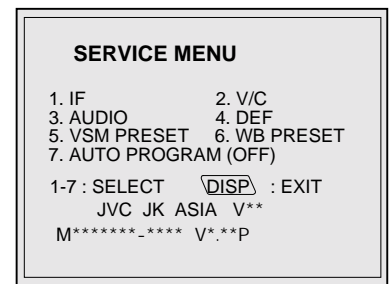
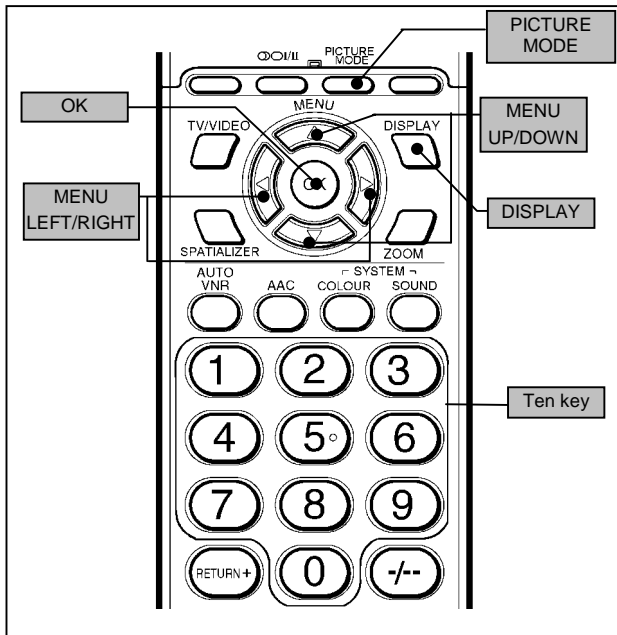
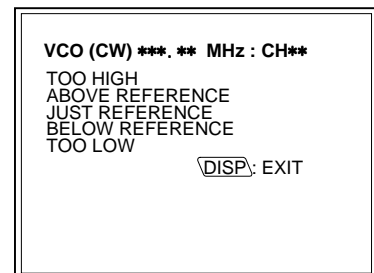

Fig.1

KEY ASSIGNMENT OF REMOTE CONTROL UNIT



SUB MENU 1.IF(VCO)



2.V/C, 4.DEF, 5.VSM PRESET and 6.WB PRESET

- ① 2, 4, 5, 6 Key Select one from **2. V/C, 4. DEF, 5. VSM PRESET** and **6.WB PRESET**.
- ② MENU UP/DOWN Key Select setting items.
- ③ MENU LEFT/RIGHT Key Set (adjust) the setting values of the setting items.
- ④ OK Key Memorize the setting value.
(Before storing the setting values in memory, do not press the CH, TV, POWER ON / OFF key - if you do, the values will not be stored in memory.)
- ⑤ DISPLAY Key Return to the **SERVICE MENU** screen.

SUB MENU 2.V/C

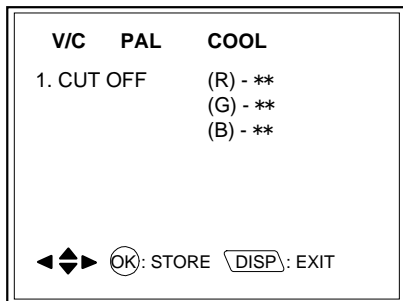

SUB MENU 4.DEF

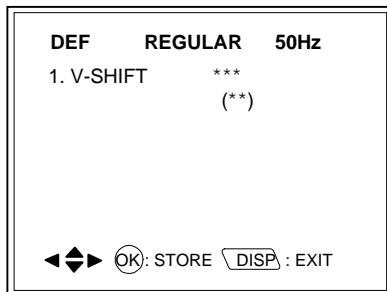

SUB MENU 5.VSM PRESET

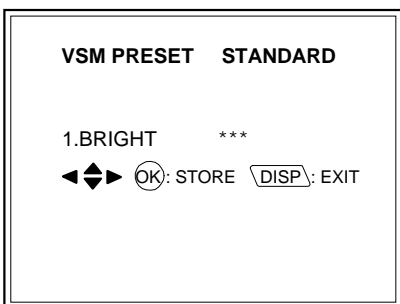

SUB MENU 6.WB PRESET

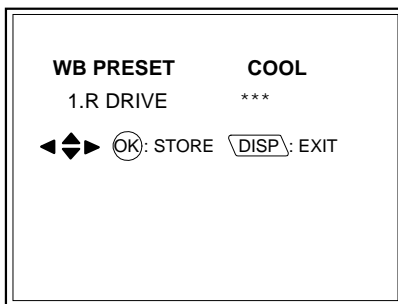

3.AUDIO and 7.AUTO PROGRAM

- 3.AUDIO (**Do not adjust**) It is not requirement to adjustment.
- 7.AUTO PROGRAM (**Do not adjust**) AUTO PROGRAM contents displays on the screen. Need not for service.

SUB MENU 3.AUDIO

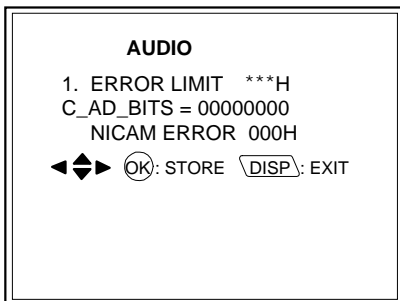

[Exit from SERVICE MENU]

When complete the adjustment work, press the **DISPLAY** key to return to the main SERVICE MENU. And then press the **DISPLAY** key again, return to the normal screen.

SERVICE MENU FLOW CHART

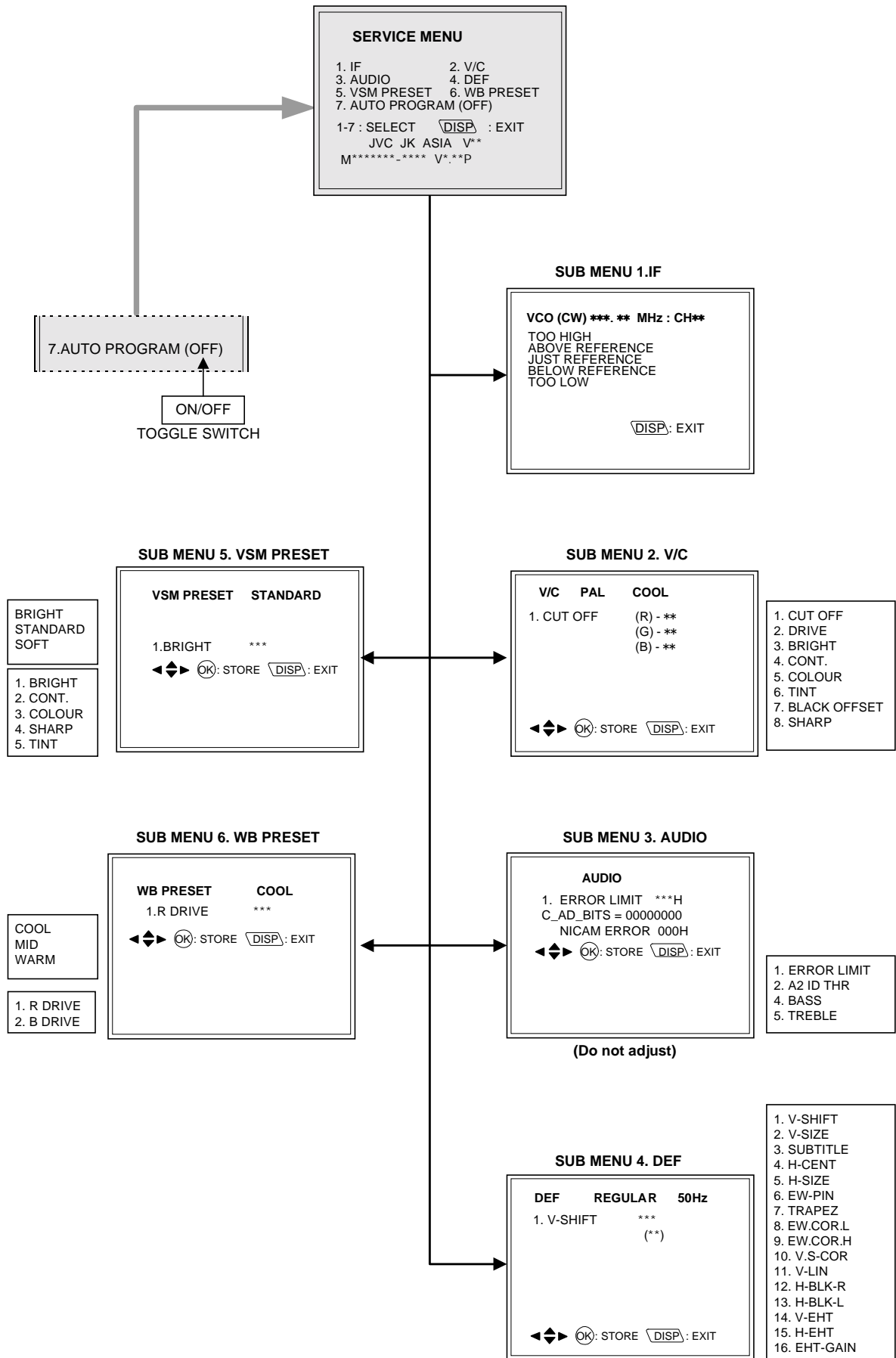

ADJUSTMENT LOCATIONS

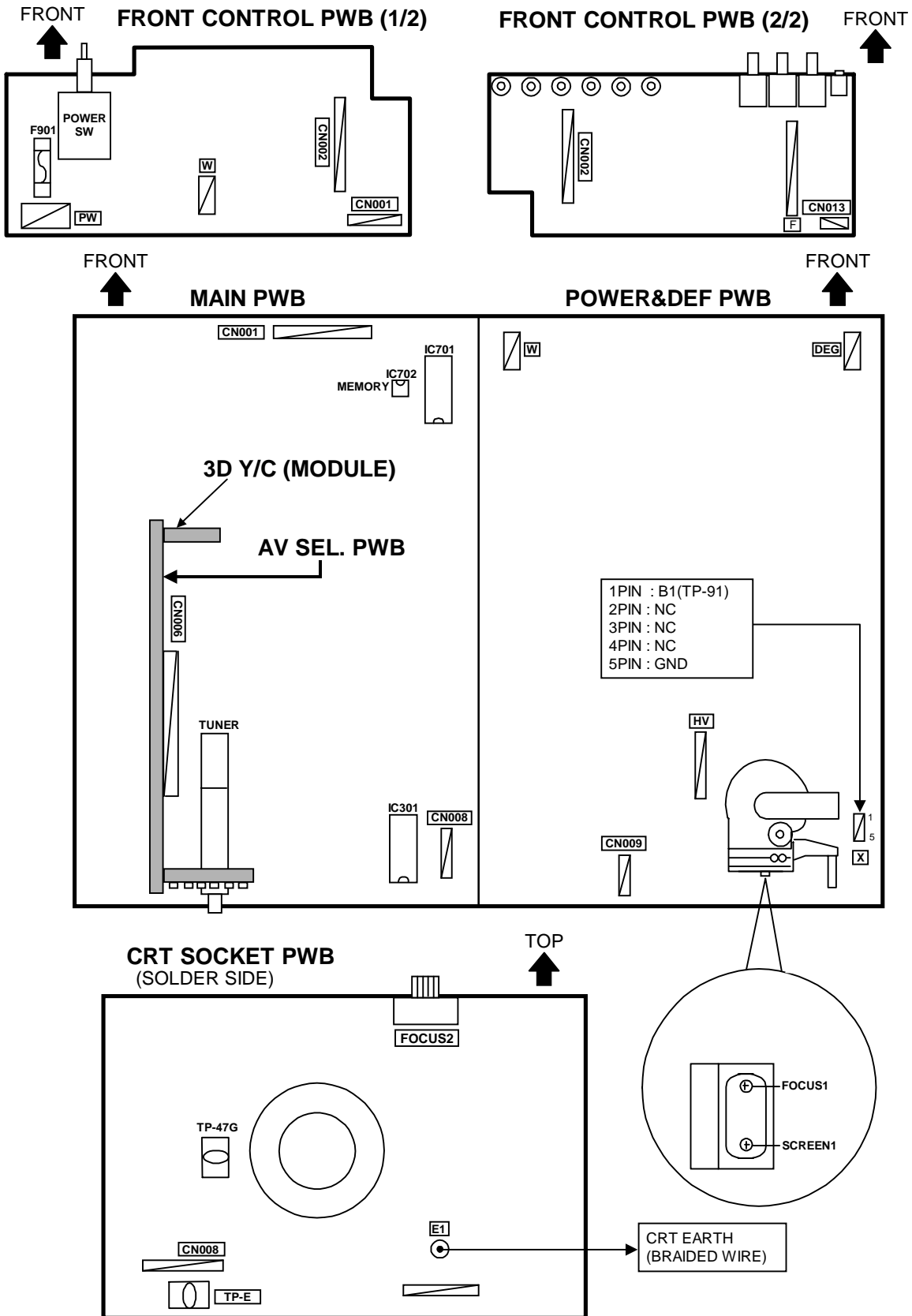

REPLACEMENT OF CHIP COMPONENT

■ CAUTIONS

1. Avoid heating for more than 3 seconds.
2. Do not rub the electrodes and the resist parts of the pattern.
3. When removing a chip part, melt the solder adequately.
4. Do not reuse a chip part after removing it.

■ SOLDERING IRON

1. Use a high insulation soldering iron with a thin pointed end of it.
2. A 30w soldering iron is recommended for easily removing parts.

■ REPLACEMENT STEPS

1. How to remove Chip parts

◆ Resistors, capacitors, etc

- (1) As shown in the figure, push the part with tweezers and alternately melt the solder at each end.

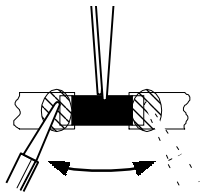

- (2) Shift with tweezers and remove the chip part.

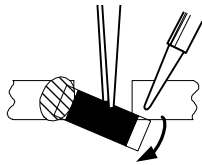

◆ Transistors, diodes, variable resistors, etc

- (1) Apply extra solder to each lead.

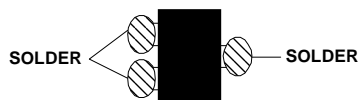

- (2) As shown in the figure, push the part with tweezers and alternately melt the solder at each lead. Shift and remove the chip part.

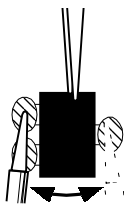

Note : After removing the part, remove remaining solder from the pattern.

2. How to install Chip parts

◆ Resistors, capacitors, etc

- (1) Apply solder to the pattern as indicated in the figure.

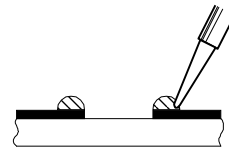

- (2) Grasp the chip part with tweezers and place it on the solder. Then heat and melt the solder at both ends of the chip part.

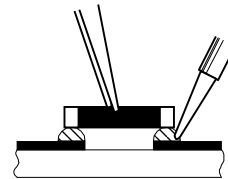

◆ Transistors, diodes, variable resistors, etc

- (1) Apply solder to the pattern as indicated in the figure.
- (2) Grasp the chip part with tweezers and place it on the solder.
- (3) First solder lead **A** as indicated in the figure.

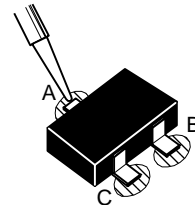

- (4) Then solder leads **B** and **C**.

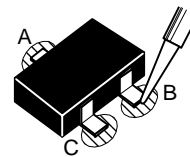

ADJUSTMENTS

CHECK ITEMS BEFORE ADJUSTMENTS

| Item | Measuring instrument | Test point | Adjustment part | Description |
|--------------------------|--|--|-----------------|--|
| Check of B1 Power Supply | Signal generator DC voltmeter | TP-91(B1) TP-E(↵) [X Connector on POWER DEF PWB] | | <ol style="list-style-type: none"> 1. Input the black and white signal. 2. Select 2. V/C from the SERVICE MENU. 3. Select 1. CUT OFF with MENU UP / DOWN key. 4. Show a horizontal line by pressing the 1 key. 5. Turn the SCREEN VR until not to display the a horizontal line. 6. Connect the DC voltmeter to TP-91(B1) and TP-E(↵). 7. Make sure that the voltage is DC134.0 \pm2.0V. 8. Readjust the SCREEN VR to appear the a horizontal line faintly, and cancel the a horizontal line by pressing the 2 key. |
| Check of High Voltage | Signal generator High voltage meter | CRT anode | | <ol style="list-style-type: none"> 1. Input the black and white signal. 2. Select 2. V/C from the SERVICE MENU. 3. Select 1. CUT OFF with MENU UP / DOWN key. 4. Show a horizontal line by pressing the 1 key. 5. Turn the SCREEN VR until not to display the a horizontal line. 6. Connect a High voltage meter to CRT ANODE. 7. Make sure that the voltage is DC 32.0kV \pm1.5kV. 8. Readjust the SCREEN VR to appear the a horizontal line faintly, and cancel the a horizontal line by pressing 2 key. |

FOCUS ADJUSTMENT

| Item | Measuring instrument | Test point | Adjustment part | Description |
|---------------------|----------------------|------------|--|---|
| Adjustment of FOCUS | Signal generator | | FOCUS 1 [In HVT] FOCUS 2 [CRT SOCKET PWB] | <ol style="list-style-type: none"> 1. Input the cross-hatch signal. 2. By turning the FOCUS1 VR, adjust the picture so that the 7th horizontal line from the upper side of the cross-hatch picture becomes thinnest. 3. By turning the FOCUS1 VR, adjust the picture so that the 7th vertical line from the left side may become uniform at the line center and its periphery. 4. Then turning the FOCUS2 VR, adjust the focus of the vertical line at most outside becomes as thin as possible. 5. Carry out adjustment by repeating the steps 2 and 3 above. 6. Make sure that when the screen is darkened, the lines remain in good focus. |

CHECK OF IF CIRCUIT

| Item | Measuring instrument | Test point | Adjustment part | Description |
|------------------------|----------------------|------------|-----------------|---|
| Adjustment of VCO (CW) | Remote control unit | | 1.IF | <ul style="list-style-type: none"> ● Under normal conditions, it is no adjustment required. ● It must not adjust without broadcast signal. <ol style="list-style-type: none"> 1. Select 1.IF from the SERVICE MENU, then displays the VCO (CW) adjustment screen. 2. Check the characters colour of the JUST REFERENCE displayed to yellow. |

VCO (CW) ** ** MHz

TOO HIGH

ABOVE REFERENCE

JUST REFERENCE ← YELLOW

BELOW REFERENCE

TOO LOW

[DISP] : EXIT

SETTING OF VSM PRESET

| Item | Measuring instrument | Test point | Adjustment part | Description |
|-----------------------|----------------------|------------|---|--|
| Setting of VSM PRESET | Remote control unit | | 5.VSM PRESET 1. BRIGHT 2. CONT. 3. COLOUR 4. SHARP 5. TINT | <ol style="list-style-type: none"> 1. Select 5.VSM PRESET from the SERVICE MENU. 2. Select PICTURE MODE to BRIGHT by the remote control unit. 3. Adjust the MENU UP/DOWN and -LEFT/RIGHT key to bring the set values of 1.BRIGHT~5. TINT to the values shown in the table. 4. Press the OK key and memorize the set value. 5. Respectively select the PICTURE MODE to STANDARD and SOFT, and make similar setting as in 3 above. 6. Press the OK key and memorize the set value. |

[INITIAL SETTING VALUES OF VSM PRESET]

| ITEM | PICTURE MODE | | |
|-----------|--------------|----------|------|
| | BRIGHT | STANDARD | SOFT |
| 1. BRIGHT | +0 | +0 | +0 |
| 2. CONT | +17 | +0 | -4 |
| 3. COLOUR | +0 | +0 | -1 |
| 4. SHARP | +0 | +0 | -3 |
| 5. TINT | +0 | +0 | +0 |

SETTING OF WHITE BALANCE PRESET

| Item | Measuring instrument | Test point | Adjustment part | Description |
|--|----------------------|---------------|---|---|
| Setting of WHITE BALANCE PRESET | Remote control unit | | 6.WB PRESET 1. R DRIVE 2. B DRIVE | 1. Select 6.WB PRESET from the SERVICE MENU. 2. Select COOL in the user setting MENU. 3. Adjust the MENU UP/DOWN and LEFT/RIGHT key to bring the set values of 1.R DRIVE & 2.B DRIVE to the values shown in the table. 4. Press the OK key and memorize the set value. 5. Respectively select the WHITE BALANCE MODE to MID and WARM, and make similar adjustment as in 3 above. 6. Press the OK key and memorize the set value. |
| [INITIAL SETTING VALUES OF WHITE BALANCE PRESET] | | | | |
| | | WHITE BALANCE | | |
| ITEM | | COOL | MID | WARM |
| 1. R DRIVE | | +0 | -3 | +26 |
| 2. B DRIVE | | +0 | -23 | -27 |

VIDEO / CHROMA CIRCUIT ADJUSTMENT

The setting (adjustment) using the REMOTE CONTROL UNIT is made on the basis of the initial setting values.
The setting values which adjust the screen to the optimum condition can be different from the initial setting values.

| CONTENTS | | PAL | SECAM | NTSC3.58 | NTSC4.43 |
|-----------------|-----------|----------|-------|-----------|----------|
| 1. CUTOFF | R | -60 | | | |
| | G | -60 | | | |
| | B | -60 | | | |
| 2. DRIVE | R | +0 | | | |
| | B | +0 | | | |
| 3. BRIGHT | TV | 0 | +3 | +1 | — |
| | VIDEO | -3 | +2 | +1 | — |
| | COMPONENT | -2 | | | |
| 4. CONT | TV | -15 | 0 | 0 | — |
| | VIDEO | 0 | 0 | 0 | — |
| | COMPONENT | +2 | | | |
| 5. COLOUR | TV/VIDEO | +10 | +18 | +0 | 0 |
| | COMPONENT | +8(50Hz) | | +17(60Hz) | |
| 6. TINT | TV | +6 | +6 | +7 | 0 |
| | VIDEO | +6 | +6 | +14 | 0 |
| | COMPONENT | +6(50Hz) | | 0(60Hz) | |
| 7. BLACK OFFSET | R-Y | — | 0 | — | — |
| | B-Y | — | 0 | — | — |
| 8. SHARP | TV | -12 | -13 | -12 | — |
| | VIDEO | -8 | -7 | -9 | — |
| | COMPONENT | -10 | | | |

| Item | Measuring instrument | Test point | Adjustment part | Description |
|---|---|------------|---|--|
| Adjustment of WHITE BALANCE (Low Light) | Signal generator Remote control unit | | 1.CUT OFF (R)** (G)** (B)** SCREEN VR [In HVT] | <ul style="list-style-type: none"> ● Set the PICTURE MODE to STANDARD. 1. Set the WHITE BALANCE to COOL. 2. Receive a black and white signal (colour off). 3. Select 2.V/C from the SERVICE MENU. 4. Select 1.CUT OFF with the MENU UP/DOWN key. 5. Show a horizontal line with the 1 key. 6. Gradually turn the SCREEN VR from the left end to the right direction to bring one of the red, green or blue colour faintly visible. 7. Press 4~9 key, and bring out the other 2 colours and make a horizontal line visible in white. 8. Turn the SCREEN VR and bring a white horizontal line faintly visible. 9. Press 2 key, turn off a horizontal line. 10. Press the OK key and memorize the set value. |
| | | | | |
| Adjustment of WHITE BALANCE (High Light) | Signal generator Remote control unit | | 2.DRIVE (R)** (B)** | <ul style="list-style-type: none"> ● The adjustment for Low Light WHITE BALANCE should be finished. ● Set the PICTURE MODE to STANDARD. 1. Set the WHITE BALANCE to COOL. 2. Input the black and white signal (colour off). 3. Select 2.V/C from the SERVICE MENU. 4. Select 2.DRIVE with the MENU UP/DOWN key. 5. Change the screen colour to white with 4 key or 7 key (drive of red), 6 key or 9 key (drive of blue). 6. Press the OK key, and memorize the set values. |
| | | | | |

| Item | Measuring instrument | Test point | Adjustment part | Description |
|----------------------------|----------------------|------------|------------------|--|
| Adjustment of SUB BRIGHT | Remote control unit | | 3.BRIGHT | <ol style="list-style-type: none"> 1. Receive any broadcast. 2. Select 2.V/C from the SERVICE MENU. 3. Select 3.BRIGHT with the MENU UP/DOWN key. 4. Set the initial setting value with the MENU LEFT/RIGHT key. 5. If the brightness is not the best with the initial setting value, make fine adjustment until you get the best brightness. 6. Press the OK key and memorize the set value. |
| Adjustment of SUB CONTRAST | Remote control unit | | 4.CONT. | <ol style="list-style-type: none"> 1. Receive any broadcast. 2. Select 2.V/C from the SERVICE MENU. 3. Select 4.CONT with the MENU UP/DOWN key. 4. Set the initial setting value with the MENU LEFT/RIGHT key. 5. If the contrast is not the best with the initial setting value, make fine adjustment until you get the best contrast. 6. Press the OK key and memorize the set value. |
| Adjustment of SUB COLOUR I | Remote control unit | | 5.COLOUR | [Adjustment method without measuring instrument] |
| | | | PAL COLOUR | <ol style="list-style-type: none"> 1. Receive the PAL broadcast. 2. Select 2.V/C from the SERVICE MENU. 3. Select 5.COLOUR with the MENU UP/DOWN key. 4. Set the initial setting value for PAL COLOUR with the MENU LEFT/RIGHT key. 5. If the colour is not the best with the initial set value, make fine adjustment until you get the best colour. 6. Press the OK key and memorize the set value. |
| | | | SECAM COLOUR | <ol style="list-style-type: none"> 1. Receive the SECAM broadcast. 2. Select 2.V/C from the SERVICE MENU. 3. Select 5.COLOUR with the MENU UP/DOWN key. 4. Set the initial setting value for SECAM COLOUR with the MENU LEFT/RIGHT key. 5. If the colour is not the best with the initial set value, make fine adjustment until you get the best colour. 6. Press the OK key and memorize the set value. |
| | | | NTSC 3.58 COLOUR | <ol style="list-style-type: none"> 1. Receive the NTSC 3.58MHz broadcast. 2. Make similar fine adjustment of NTSC 3.58 COLOUR in the same manner as for above. |
| | | | NTSC 4.43 COLOUR | <ol style="list-style-type: none"> 1. When NTSC 3.58 is set, NTSC 4.43 will be automatically set at the respective values. |

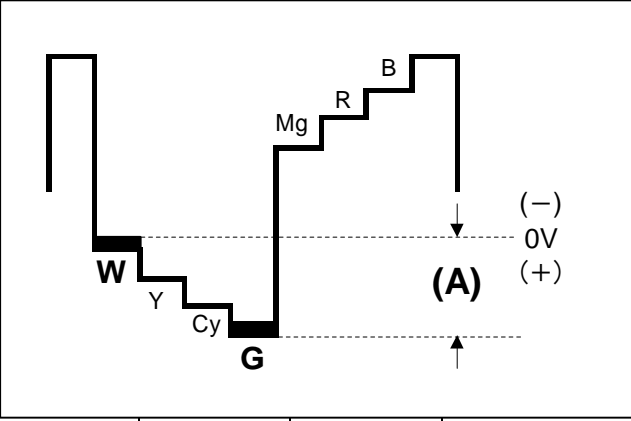
| Item | Measuring instrument | Test point | Adjustment part | Description |
|-----------------------------|---|--|---|--|
| Adjustment of SUB COLOUR II | Signal generator Oscilloscope Remote control unit | TP-47G TP-E(↕) [CRT SOCKET PWB] | 5.COLOUR | [Adjustment method using measuring instrument] |
| | | | PAL COLOUR | 1. Input the PAL full field colour bar signal (with 75% white). 2. Select 2.V/C from the SERVICE MENU. 3. Select 5.COLOUR with the MENU UP/DOWN key. 4. Set the initial setting value of PAL COLOUR with the MENU LEFT/RIGHT key. 5. Connect the oscilloscope between TP-47G and TP-E(↕). 6. Adjust PAL COLOUR to bring the value of (A) in the illustration to -3V (Voltage difference between white (W) and green (G)). 7. Press the OK key and memorize the setting value. |
| | | |  | |
| | | | SECAM COLOUR | 1. Input the SECAM full field colour bar signal (with 75% white). 2. Set the initial setting value of SECAM COLOUR with the MENU LEFT/RIGHT key. 3. Adjust SECAM COLOUR to bring the value of (A) in the illustration to -5V (Voltage difference between white (W) and green (G)). 4. Press the OK key and memorize the setting value. |
| NTSC COLOUR | 1. Input the NTSC 3.58MHz full field colour bar signal (with 75% white). 2. Set the initial setting value of NTSC 3.58 COLOUR with the MENU LEFT/RIGHT key. 3. Adjust NTSC 3.58 COLOUR and bring the value of (A) in the illustration to +3V (Voltage difference between white (W) and green (G)). 4. Press the OK key and memorize the setting value. | | | |
| NTSC 4.43 COLOUR | 1. When NTSC 3.58 is set, NTSC 4.43 will be automatically set at the respective values. | | | |

| Item | Measuring instrument | Test point | Adjustment part | Description |
|---------------------------|---|---------------------------------------|-----------------|---|
| Adjustment of SUB TINT I | Remote control unit | | 6.TINT | [Adjustment method without measuring instrument] |
| | | | NTSC 3.58 TINT | <ol style="list-style-type: none"> 1. receive the NTSC 3.58MHz broadcast. 2. Select 2.V/C from the SERVICE MENU. 3. Select 6. TINT with the MENU UP/DOWN key. 4. Set the initial setting value of NTSC 3.58 TINT with the MENU LEFT/RIGHT key. 5. If you cannot get the best tint with the initial setting value, make fine adjustment until you get the best tint. 6. Press the OK key and memorize the set value. |
| | | | NTSC 4.43 TINT | <ol style="list-style-type: none"> 1. When NTSC 3.58 is set, NTSC 4.43 will be automatically set at the respective values. |
| Adjustment of SUB TINT II | Signal generator Oscilloscope Remote control unit | TP-47G TP-E(↵) [CRT SOCKET PWB] | 6. TINT | [Adjustment method using measuring instrument] |
| | | | NTSC 3.58 TINT | <ol style="list-style-type: none"> 1. Input the NTSC 3.58MHz full field colour bar signal (with 75% white). 2. Select 2.V/C from the SERVICE MENU. 3. Select 6. TINT with the MENU UP/DOWN key. 4. Set the initial setting value of NTSC 3.58 TINT with the MENU LEFT/RIGHT key. 5. Connect the oscilloscope between TP-47G and TP-E(↵) 6. Adjust NTSC 3.58 TINT to bring the value of (B) in the illustration to +4V (voltage difference between white (W) and cyan (Cy)). 7. Press the OK key and memorize the setting value |
| | | | NTSC 4.43 TINT | <ol style="list-style-type: none"> 1. When NTSC 3.58 is set, NTSC 4.43 will be automatically set at the respective values. |

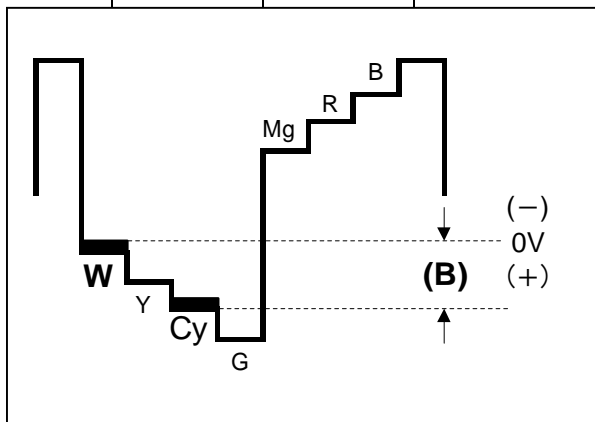

| Item | Measuring instrument | Test point | Adjustment part | Description | | | | | | | | | | | | | | | | | | | | | | | | | | | | | | |
|---|--|--|---|---|---|---|---|---|---|---|---|---|---|---|---|---|---|---|---|---|---|--------|--|--------|--------|--|--------|---|--|---|------------|--|------------|---|
| <p>Adjustment Of SECAM BLACK OFFSET-I</p> | <p>Remote control unit</p> | | <p>7. BLACK OFFSET (R-Y) (B-Y)</p> | <p>[Method of adjustment without measuring instrument]</p> <ol style="list-style-type: none"> 1. Receive the SECAM broadcast. 2. Select 2. V/C from SERVICE MENU. 3. Select 7. BLACK OFFSET with the MENU UP / DOWN key. 4. Set the initial setting value for 7. BLACK OFFSET (R-Y) and (B-Y) with 4 and 7 or 6 and 9 keys of the remote control. 5. If the picture is not the best with the initial setting value, make fine adjustment until you get the best picture. 6. Press the OK key and memorise the set value. | | | | | | | | | | | | | | | | | | | | | | | | | | | | | | |
| <div style="border: 1px solid black; padding: 10px; text-align: center;"> <p>REMOTE CONTROL UNIT</p> <table style="width: 100%; border-collapse: collapse;"> <tr> <td style="width: 33%; text-align: center;">1</td> <td style="width: 33%; text-align: center;">2</td> <td style="width: 33%; text-align: center;">3</td> </tr> <tr> <td style="text-align: center;">○</td> <td style="text-align: center;">○</td> <td style="text-align: center;">○</td> </tr> <tr> <td style="text-align: center;">4</td> <td style="text-align: center;">5</td> <td style="text-align: center;">6</td> </tr> <tr> <td style="text-align: center;">○</td> <td style="text-align: center;">○</td> <td style="text-align: center;">○</td> </tr> <tr> <td style="text-align: center;">7</td> <td style="text-align: center;">8</td> <td style="text-align: center;">9</td> </tr> <tr> <td style="text-align: center;">○</td> <td style="text-align: center;">○</td> <td style="text-align: center;">○</td> </tr> <tr> <td style="text-align: center;">R-Y(▲)</td> <td></td> <td style="text-align: center;">B-Y(▲)</td> </tr> <tr> <td style="text-align: center;">R-Y(▼)</td> <td></td> <td style="text-align: center;">B-Y(▼)</td> </tr> <tr> <td style="text-align: center;">↑</td> <td></td> <td style="text-align: center;">↑</td> </tr> <tr> <td style="text-align: center;">(R)</td> <td></td> <td style="text-align: center;">(B)</td> </tr> </table> </div> | | | | 1 | 2 | 3 | ○ | ○ | ○ | 4 | 5 | 6 | ○ | ○ | ○ | 7 | 8 | 9 | ○ | ○ | ○ | R-Y(▲) | | B-Y(▲) | R-Y(▼) | | B-Y(▼) | ↑ | | ↑ | (R) | | (B) | <p>[Method of adjustment using measuring instrument]</p> <ol style="list-style-type: none"> 1. Input the SECAM full field colour bar signal (with 75% white). 2. Select 2. V/C from SERVICE MENU. 3. Select 7. BLACK OFFSET with the MENU UP / DOWN key. 4. Connect the oscilloscope between 35 pin of IC 1301 and TP-E. 5. By using 4 and 7 keys of the remote control, adjust the BLACK OFFSET (R-Y) so that it becomes the waveform changes from (A) to (B) shown in the figure. 6. Connect the oscilloscope between 36 pin of IC 1301 and TP-E. 7. By using 6 and 9 keys of the remote control, adjust the BLACK OFFSET (B-Y) so that it becomes the waveform changes from (C) to (D) shown in the figure. 8. If the picture is not the best with the adjusted picture, make fine adjustment until you get the best picture. 9. Press the OK key twice to return to the normal screen. |
| 1 | 2 | 3 | | | | | | | | | | | | | | | | | | | | | | | | | | | | | | | | |
| ○ | ○ | ○ | | | | | | | | | | | | | | | | | | | | | | | | | | | | | | | | |
| 4 | 5 | 6 | | | | | | | | | | | | | | | | | | | | | | | | | | | | | | | | |
| ○ | ○ | ○ | | | | | | | | | | | | | | | | | | | | | | | | | | | | | | | | |
| 7 | 8 | 9 | | | | | | | | | | | | | | | | | | | | | | | | | | | | | | | | |
| ○ | ○ | ○ | | | | | | | | | | | | | | | | | | | | | | | | | | | | | | | | |
| R-Y(▲) | | B-Y(▲) | | | | | | | | | | | | | | | | | | | | | | | | | | | | | | | | |
| R-Y(▼) | | B-Y(▼) | | | | | | | | | | | | | | | | | | | | | | | | | | | | | | | | |
| ↑ | | ↑ | | | | | | | | | | | | | | | | | | | | | | | | | | | | | | | | |
| (R) | | (B) | | | | | | | | | | | | | | | | | | | | | | | | | | | | | | | | |
| <p>Adjustment Of SECAM BLACK OFFSET-II</p> | <p>Signal generator Oscilloscope Remote control unit</p> | <p>35 PIN (R-Y) 36 PIN (B-Y) IC 1301 On MAIN PWB</p> | <p>7. BLACK OFFSET (R-Y) (B-Y)</p> | <p>[Method of adjustment using measuring instrument]</p> <ol style="list-style-type: none"> 1. Input the SECAM full field colour bar signal (with 75% white). 2. Select 2. V/C from SERVICE MENU. 3. Select 7. BLACK OFFSET with the MENU UP / DOWN key. 4. Connect the oscilloscope between 35 pin of IC 1301 and TP-E. 5. By using 4 and 7 keys of the remote control, adjust the BLACK OFFSET (R-Y) so that it becomes the waveform changes from (A) to (B) shown in the figure. 6. Connect the oscilloscope between 36 pin of IC 1301 and TP-E. 7. By using 6 and 9 keys of the remote control, adjust the BLACK OFFSET (B-Y) so that it becomes the waveform changes from (C) to (D) shown in the figure. 8. If the picture is not the best with the adjusted picture, make fine adjustment until you get the best picture. 9. Press the OK key twice to return to the normal screen. | | | | | | | | | | | | | | | | | | | | | | | | | | | | | | |
| <div style="border: 1px solid black; padding: 10px; text-align: center;"> <p>[R-Y]</p> <p>(A) → (B)</p> </div> | | | | | | | | | | | | | | | | | | | | | | | | | | | | | | | | | | |
| <div style="border: 1px solid black; padding: 10px; text-align: center;"> <p>[B-Y]</p> <p>(C) → (D)</p> </div> | | | | | | | | | | | | | | | | | | | | | | | | | | | | | | | | | | |

DEFLECTION CIRCUIT ADJUSTMENT

There are 3 modes of the adjustment (1) 50Hz mode (①REGULAR ②ZOOM ③16:9), (2) 60Hz mode (each aspect mode) depending upon the kind of signals (vertical frequency 50Hz / 60Hz).

The adjustment using the remote control unit is made on the basis of the initial setting values.
The setting values which adjust the screen to the optimum condition can be different from the initial setting values.

DEFLECTION ADJUSTMENTS INITIAL SETTING VALUE

| Setting item | Adjustment name | Initial setting value | | | | | |
|--------------|--|-----------------------|------|------|------|------|------|
| | | REGULAR | | ZOOM | | 16:9 | |
| | | 50Hz | 60Hz | 50Hz | 60Hz | 50Hz | 60Hz |
| 1. V-SHIFT | Vertical center | -5 | -1 | 0 | +1 | 0 | 0 |
| 2. V-SIZE | Vertical height | +7 | -1 | +36 | +35 | -39 | -39 |
| 3. SUB TITLE | Sub title | 0 | +1 | -7 | +7 | 0 | 0 |
| 4. H-CENT | Horizontal center | -10 | +5 | -1 | -1 | 0 | -1 |
| 5. H-SIZE | Horizontal size | -12 | -1 | -4 | -4 | 0 | -1 |
| 6. EW-PIN | Side pin correction | -3 | +1 | -4 | -4 | +2 | 0 |
| 7. TRAPEZ | Trapezoidal distortion correction | +4 | -2 | 0 | -1 | 0 | +1 |
| 8. EW.COR.L | Corner pin correction Low side | -2 | 0 | -1 | -1 | +1 | +1 |
| 9. EW.COR.H | Corner pin correction High side | -2 | 0 | 0 | 0 | +1 | +1 |
| 10. V.S-COR | Vertical size correction | +13 | 0 | 0 | 0 | 0 | 0 |
| 11. V-LIN | Vertical Linearity | +2 | -1 | -1 | -1 | +1 | 0 |
| 12. H-BLK-R | Horizontal blanking right | 0 | 0 | 0 | 0 | +77 | 0 |
| 13. H-BLK-L | Horizontal blanking left | 0 | 0 | 0 | 0 | +2 | 0 |
| 14. V-EHT | V size correction level caused by EHT change | -4 | 0 | 0 | 0 | 0 | 0 |
| 15.H-EHT | H size correction level caused by EHT change | -3 | 0 | 0 | 0 | 0 | 0 |
| 16.EHT-GAIN | Size correction gain caused by EHT change | +3 | 0 | 0 | 0 | 0 | 0 |

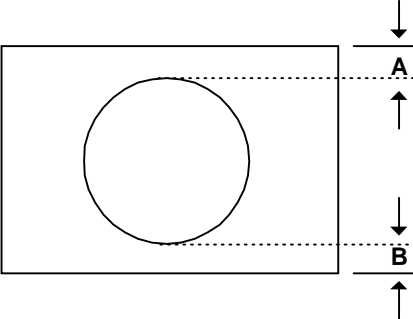
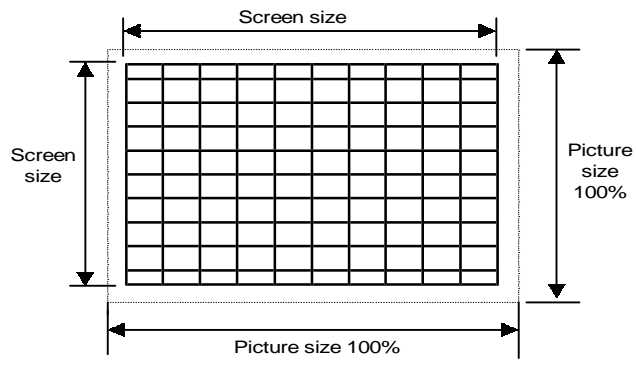
| Item | Measuring instrument | Test point | Adjustment part | Description | | | | | | | | |
|--|---|------------|-------------------------|--|-------------|---------|------|--------|--------|-----|-----|-------------------------|
| Adjustment of V-SHIFT | Signal generator Remote control unit | | 1.V- SHIFT | <p>●At first, select the ASPECT mode to REGULAR.</p> <ol style="list-style-type: none"> 1. Input the circle pattern signal. 2. Select 4.DEF from the SERVICE MENU. 3. Select 1.V-SHIFT with the MENU UP/DOWN key. 4. Adjust V-SHIFT to make A = B. 5. Press the OK key and memorize the set value. | | | | | | | | |
|  <p>The diagram shows a rectangular screen with a circle inside. Two horizontal dashed lines extend from the top and bottom of the circle to the right edge of the screen. On the right side, there are two vertical double-headed arrows. The top arrow is labeled 'A' and spans the distance from the top edge of the screen to the top dashed line. The bottom arrow is labeled 'B' and spans the distance from the bottom edge of the screen to the bottom dashed line.</p> | | | | | | | | | | | | |
| Adjustment of V-SIZE | Signal generator Remote control unit | | 2.V-SIZE | <ol style="list-style-type: none"> 6. Input the cross-hatch signal. 7. Select 2.V-SIZE and set the initial setting value. 8. Adjust V-SIZE and make sure that the vertical screen size is in the bellow table. 9. Press the OK key and memorize the set value. <p>●The value about 16:9 mode is the length of the 90% position in the screen size.</p> | | | | | | | | |
|  <p>The diagram shows a grid of 10x10 squares. The outermost grid is labeled 'Screen size' on both the top and left sides. Inside it, a smaller grid is labeled 'Picture size 100%' on both the bottom and right sides. The vertical distance between the top and bottom edges of the inner grid is also labeled 'Picture size 100%'.</p> | | | | | | | | | | | | |
| [VERTICAL SIZE] | | | | | | | | | | | | |
| <table border="1" style="width: 100%; border-collapse: collapse; text-align: center;"> <thead> <tr> <th style="width: 30%;">ASPECT MODE</th> <th style="width: 20%;">REGULAR</th> <th style="width: 20%;">ZOOM</th> <th style="width: 30%;">16 : 9</th> </tr> </thead> <tbody> <tr> <td>V-SIZE</td> <td>92%</td> <td>74%</td> <td>295mm (90% position)</td> </tr> </tbody> </table> | | | | | ASPECT MODE | REGULAR | ZOOM | 16 : 9 | V-SIZE | 92% | 74% | 295mm (90% position) |
| ASPECT MODE | REGULAR | ZOOM | 16 : 9 | | | | | | | | | |
| V-SIZE | 92% | 74% | 295mm (90% position) | | | | | | | | | |

| Item | Measuring instrument | Test point | Adjustment part | Description | | | | | | | | |
|--|---|------------|-----------------|---|-------------|---------|------|------|--------|-----|-----|-----|
| Adjustment of H-CENTER | Signal generator Remote control unit | | 4.H-CENT. | 10. Input the circle pattern signal. 11. Select 4.H-CENT and set the initial setting value. 12. Adjust H-CENT to make $C=D$. 13. Press the OK key and memorize the set value. | | | | | | | | |
| <p>The diagram shows a circle centered on a rectangular screen. Two horizontal double-headed arrows, labeled 'C' and 'D', indicate the distance from the left and right edges of the screen to the vertical centerline of the circle, respectively. Dotted vertical lines extend from the ends of these arrows to the centerline of the circle.</p> | | | | | | | | | | | | |
| Adjustment of H-SIZE | Signal generator Remote control unit | | 5.H-SIZE | 14. Input the circle pattern signal. 15. Select 5.H-SIZE and set the initial setting value. 16. Adjust H-SIZE and make sure that the horizontal screen size of the picture is in the bellow table. 17. Press the OK key and memorize the set value. | | | | | | | | |
| [HORIZONTAL SIZE] | | | | | | | | | | | | |
| <table border="1" style="width: 100%; border-collapse: collapse; text-align: center;"> <thead> <tr> <th style="width: 25%;">ASPECT MODE</th> <th style="width: 25%;">REGULAR</th> <th style="width: 25%;">ZOOM</th> <th style="width: 25%;">16:9</th> </tr> </thead> <tbody> <tr> <td>H-SIZE</td> <td>92%</td> <td>85%</td> <td>92%</td> </tr> </tbody> </table> | | | | | ASPECT MODE | REGULAR | ZOOM | 16:9 | H-SIZE | 92% | 85% | 92% |
| ASPECT MODE | REGULAR | ZOOM | 16:9 | | | | | | | | | |
| H-SIZE | 92% | 85% | 92% | | | | | | | | | |
| Adjustment of EW-PIN | Signal generator Remote control unit | | 6.EW-PIN | 18. Select 6.EW-PIN and set the initial setting value 19. Adjust EW-PIN and make the 2nd vertical lines at the left and right edges of the screen straight. Also make sure that the 3rd vertical lines are straight. 20. Press the OK key and memorize the set value. | | | | | | | | |
| <p>The diagram shows a 10x10 grid. Two vertical dashed lines are drawn through the grid, one near the left edge and one near the right edge. A horizontal double-headed arrow labeled 'Straight' spans the distance between these two lines. Small horizontal arrows point inward from the 2nd and 3rd vertical lines of the grid towards the dashed lines, indicating the adjustment direction.</p> | | | | | | | | | | | | |

| Item | Measuring instrument | Test point | Adjustment part | Description |
|------------------------------------|---|------------|------------------------------|--|
| Adjustment of TRAPEZ. | Signal generator Remote control unit | | 7.TRAPEZ. | 21. Input the cross-hatch signal. 22. Select 7.TRAPEZ with the MENU UP/DOWN key. 23. Set the initial setting value of TRAPEZ with the MENU LEFT/RIGHT key. 24. Adjust TRAPEZ and bring the vertical lines at the right and left edges of the screen parallel . 25. Press the OK key and memorize the set value. |
| Adjustment of EW. COR. L/H | Signal generator Remote control unit | | 8.EW. COR. L 9.EW. COR. H | 26. Select 8.EW. COR. L with the MENU UP / DOWN key. 27. Set the initial setting value of EW. COR. L with the MENU LEFT/RIGHT key. 28. Adjust EW. COR. L, and bring the line to straight at the corner of the screen bottom. 29. Select 9.EW. COR. H with the MENU UP / DOWN key. 30. Set the initial setting value of EW. COR. H with the MENU LEFT/RIGHT key. 31. Adjust EW. COR. H, and bring the line to straight at the corner of the screen top. 32. Press the OK key and memorize the set value. |
| Adjustment of V-S.CR & V.LINEARITY | Signal generator Remote control unit | | 10. V-S.CR 11. V-LIN | <p>● In case when the vertical linearity has been deteriorated remarkably, perform the following steps.</p> 33. Input the cross-hatch signal. 34. Select 11.V-LIN with the MENU UP/DOWN key. 35. Set the initial setting value of 11.V-LIN with the MENU LEFT/RIGHT key. 36. Select 10.V-S.CR with the MENU UP / DOWN key. 37. Set the initial setting value of 10.V-S.CR with the MENU LEFT/RIGHT key. 38. Adjust 11.V-LIN and 10.V-S.CR so that the spaces of each line on top, center and bottom become uniform. |

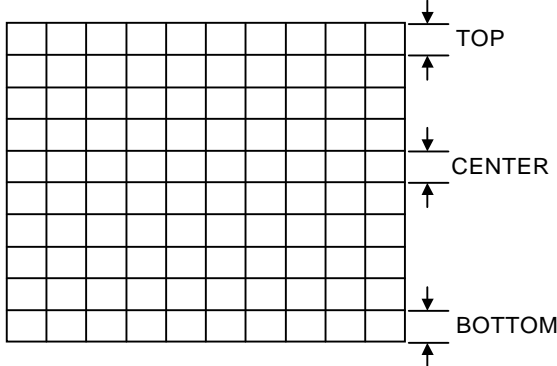
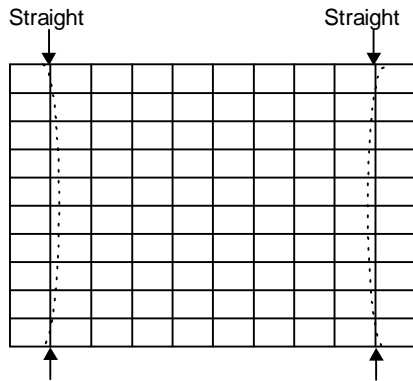
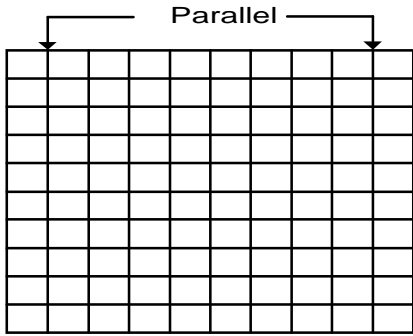

| Item | Measuring instrument | Test point | Adjustment part | Description |
|------|----------------------|------------|-----------------|---|
| | | | | At first the adjustment in 50Hz-REGULAR mode should be done, then the data for the other aspect mode is corrected in the respective value at the same time. And confirm the deflection adjustment initial setting value in 60Hz(NTSC Video mode) REGULAR mode. If the adjustment in 50Hz each aspect mode has been done and stored, the data for the same aspect modes in 60Hz is corrected in the respective value. Only the data for the other aspect mode in 60Hz is corrected for itself. |

AUDIO CIRCUIT ADJUSTMENT

Do not adjust 3.AUDIO(1. ERROR LIMIT, 2. A2 ID THR, 3. BASS, 4. TREBLE) of the SERVICE MENU as it requires no adjustment.

3. AUDIO [Do not adjust]

| Setting item | Variable range | fixed value |
|----------------|----------------|-------------|
| 1. ERROR LIMIT | 000H ~ FF0H | 100H |
| 2. A2 ID THR | 00H ~ FFH | 14H |
| 3. BASS | -17 ~ +17 | +0 |
| 4. TREBLE | -17 ~ +17 | +0 |

PURITY, CONVERGENCE ADJUSTMENT

PURITY ADJUSTMENT

1. Demagnetize CRT with the demagnetizer.
2. Loosen the retainer screw of the deflection yoke.
3. Remove the wedges.
4. Input a green raster signal from the signal generator, and turn the screen to green raster.
5. Move the deflection yoke backward.
6. Bring the long lug of the purity magnets on the short lug and position them horizontally. (Fig.2)
7. Adjust the gap between two lugs so that the GREEN RASTER will come into the center of the screen. (Fig.3)
8. Move the deflection yoke forward, and fix the position of the deflection yoke so that the whole screen will become green.
9. Insert the wedge to the top side of the deflection yoke so that it will not move.
10. Input a crosshatch signal.
11. Verify that the screen is horizontal.
12. Input red and blue raster signals, and make sure that purity is properly adjusted.

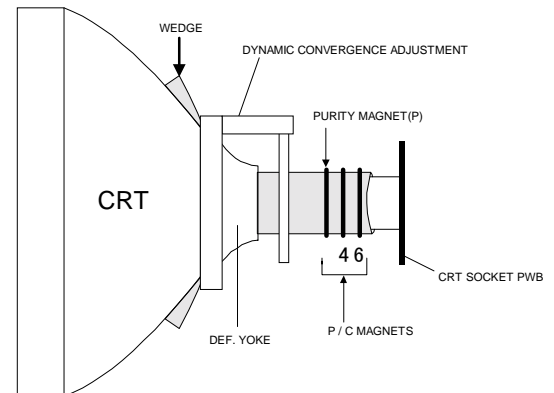

P/C MAGNETS

P : PURITY MAGNET
 4 : 4 POLES (convergence magnets)
 6 : 6 POLES (convergence magnets)

Fig.1

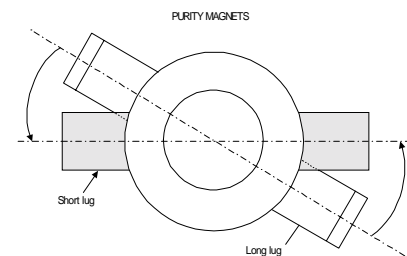

Bring the long lug over the short lug and position them horizontally.

Fig.2

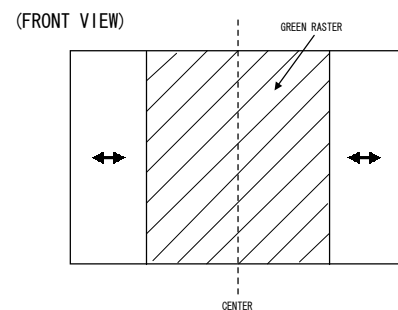

Fig.3

STATIC CONVERGENCE ADJUSTMENT

1. Input a crosshatch signal.
 2. Using 4-pole convergence magnets, overlap the red and blue lines in the center of the screen (Fig.1) and turn them to magenta (red/blue).
 3. Using 6-pole convergence magnets, overlap the magenta (red/blue) and green lines in the center of the screen and turn them to white.
 4. Repeat 2 and 3 above, and make best convergence.
- After adjustment, fix the wedge at the original position. Fasten the retainer screw of the deflection yoke. Fix the 6 magnets with glue.

DYNAMIC (periphery) CONVERGENCE ADJUSTMENT

After adjusting purity & static convergence.

1. Move the deflection yoke up and down to adjust the pin cushion distortion in the screen top and bottom. (See Fig. 2)
2. Move the deflection yoke left to right to overlap the lines in the periphery, and match the Y_v . (See Fig. 4)
3. Using the VR1 on the deflection yoke, match the Y_H (CROSS). (See Fig. 3 and 6)
4. Using the VR2 on the deflection yoke, match the Y_H (BOW). (See Fig. 3 and 6)
5. Repeat the steps 1 and 4 and obtain an optimum convergence.
6. Differential coil ADJUSTMENT.
In case where the horizontal lines of red and blue around the center of both sides of the picture as shown in Fig. 5, adjust the X_v difference by using the differential coil on the top of the deflection yoke (Fig. 6) so as to minimize the X_v difference.

(FRONT VIEW)

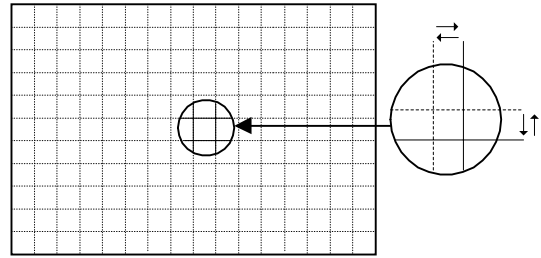

Fig. 1

(FRONT VIEW)

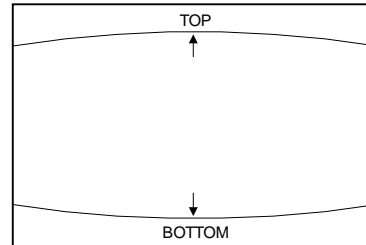

Fig. 2

(FRONT VIEW)

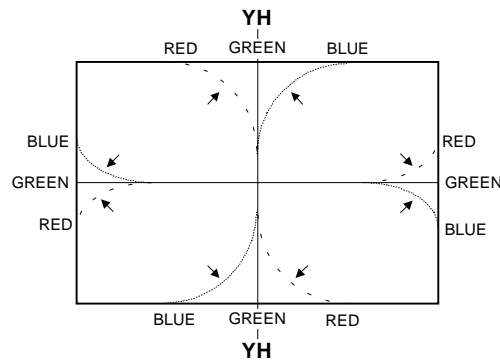

Fig. 3

(FRONT VIEW)

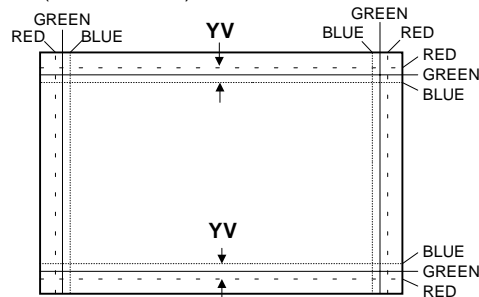

Fig. 4

(FRONT VIEW)

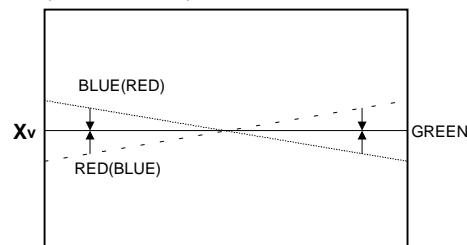

Fig. 5

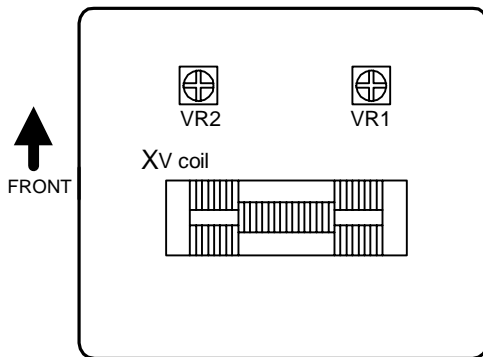

Fig. 6